

Question 1(a) [3 marks]

Draw the construction of SCR and explain it.

Answer:

SCR (Silicon Controlled Rectifier) is a four-layer PNPN semiconductor device with three terminals: Anode, Cathode, and Gate.

Diagram:

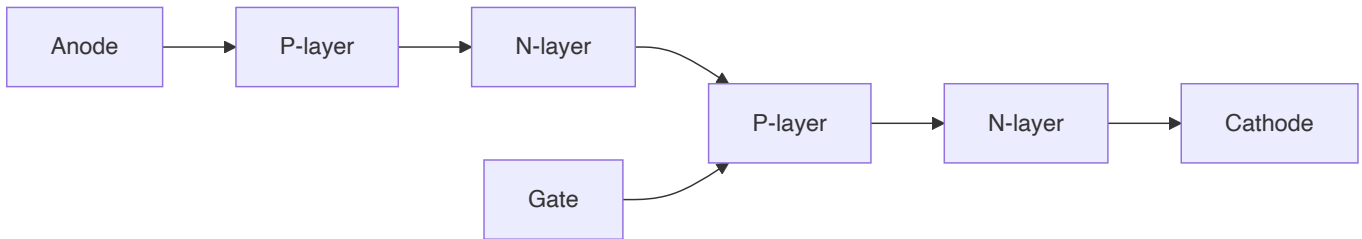

- **P-N-P-N Layers:** Four alternating semiconductor layers
- **Gate Terminal:** Controls turn-on of the device
- **Current Flow:** Anode to cathode when triggered

Mnemonic: "Silicon Controls Rectification" - SCR controls current flow in one direction only when triggered.

Question 1(b) [4 marks]

Draw construction of TRIAC and explain it.

Answer:

TRIAC (Triode for Alternating Current) is a bidirectional three-terminal semiconductor device that conducts in both directions when triggered.

Diagram:

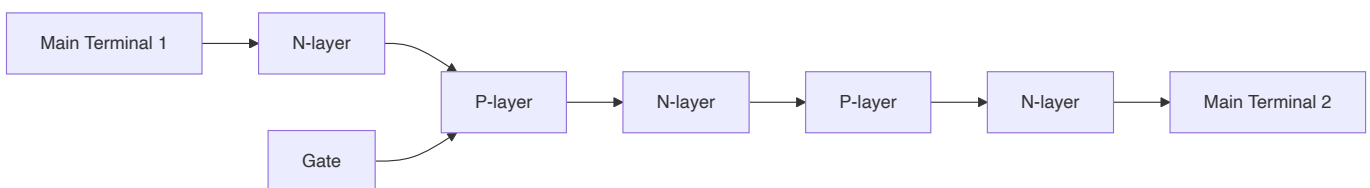

- **Bidirectional Operation:** Conducts in both directions when triggered
- **Gate Control:** Single gate controls conduction in both directions
- **Equivalent Circuit:** Acts like two SCRs connected in anti-parallel
- **AC Applications:** Widely used for AC power control applications

Mnemonic: "TRI-direction AC controller" - Controls current in both directions in AC circuits.

Question 1(c) [7 marks]

Describe construction & working of Opto-Isolators, Opto-TRIAC, Opto-SCR, and Opto-transistor. And list their applications.

Answer:

Opto-isolators use light to transfer electrical signals between isolated circuits.

Diagram:

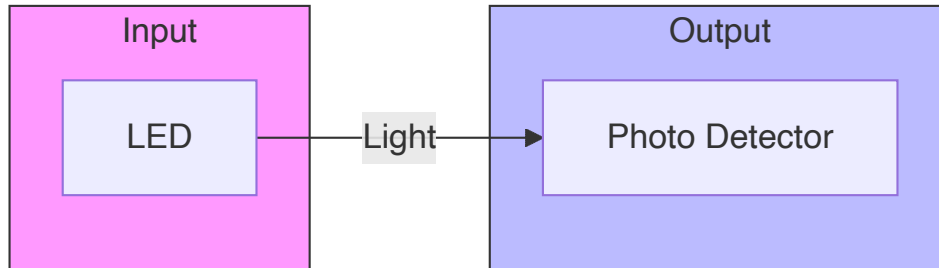

Device	Construction	Working	Applications
Opto-Isolator	LED + Photodetector	LED emits light when input current flows; photodetector activates output circuit	Signal isolation, Medical equipment, Industrial controls
Opto-TRIAC	LED + Photo-TRIAC	LED triggers the TRIAC through light; provides electrical isolation	AC power control, Solid state relays, Motor controls
Opto-SCR	LED + Photo-SCR	LED emits light to trigger SCR; provides high isolation	DC switching, Industrial controls, High voltage isolation
Opto-transistor	LED + Photo-transistor	LED light controls base current of phototransistor	Encoders, Level detection, Position sensing

- **Electrical Isolation:** Complete separation between input and output
- **Noise Immunity:** High resistance to electrical noise
- **Speed:** Response times in microseconds range

Mnemonic: "LOST" - Light Operates Semiconductor Terminals in all opto-devices.

Question 1(c) OR [7 marks]

Describe Explain working of SCR using two transistor analogies. List the various industrial applications of SCR.

Answer:

SCR can be modeled as two interconnected transistors: PNP (T1) and NPN (T2).

Diagram:

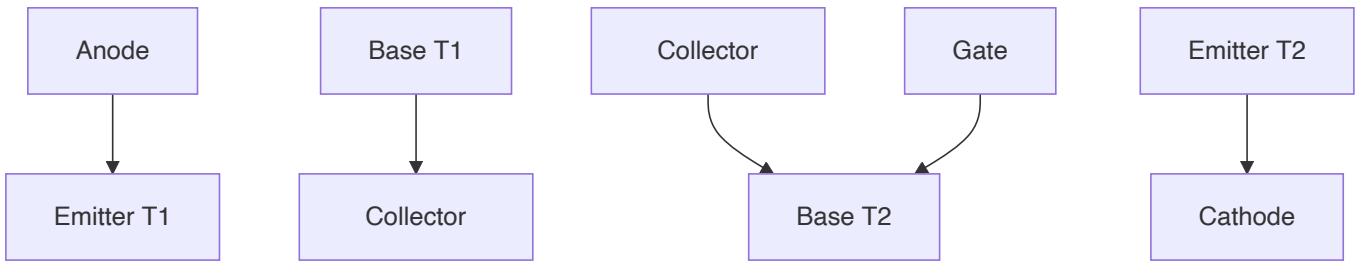

Working Principle:

Step	Operation
Initial State	Both transistors are OFF
Gate Triggering	Current injected into gate (B2 of T2)
Regenerative Action	T2 turns ON → T1 base gets current → T1 turns ON → More current to T2 base
Latching	Self-sustaining current flow continues even if gate signal is removed

Industrial Applications of SCR:

- **Power Control:** AC/DC motor speed control
- **Switching:** Static switches, solid-state relays
- **Inverters:** DC to AC conversion
- **Protection:** Overvoltage protection circuits
- **Lighting:** Light dimmers, illumination control

Mnemonic: "POWER" - Power control, Overvoltage protection, Welding machines, Electronic converters, Regulated supplies.

Question 2(a) [3 marks]

Define Triggering in SCR and explain any two triggering techniques.

Answer:

Triggering is the process of turning ON an SCR by applying appropriate signal to its gate terminal.

Two Triggering Techniques:

Technique	Description
Gate Triggering	Direct current pulse applied to gate-cathode circuit
Light Triggering	Photons striking junction provide energy for conduction

- **Gate Triggering:** Most common method using electrical pulse
- **Light Triggering:** Uses photosensitive semiconductor properties

Mnemonic: "GET" - Gate Electrical Triggering is the most common method.

Question 2(b) [4 marks]

Write the differences between forced commutation and natural commutation.

Answer:

Parameter	Forced Commutation	Natural Commutation
Definition	External circuitry forces SCR to turn OFF	SCR turns OFF naturally when current falls below holding value
Application	DC circuits	AC circuits
Components	Requires additional components (capacitors, inductors)	No additional components needed
Complexity	Complex circuit design	Simple circuit design
Energy	External energy needed for turn-off	No external energy needed

- **Forced Commutation:** Actively turns OFF SCR using external circuit
- **Natural Commutation:** SCR turns OFF when AC current crosses zero

Mnemonic: "FACE" - Forced Active Commutation requires External components.

Question 2(c) [7 marks]

Design the snubber circuit for SCR.

Answer:

Snubber circuit protects SCR from high dV/dt and limits rate of voltage rise.

Diagram:

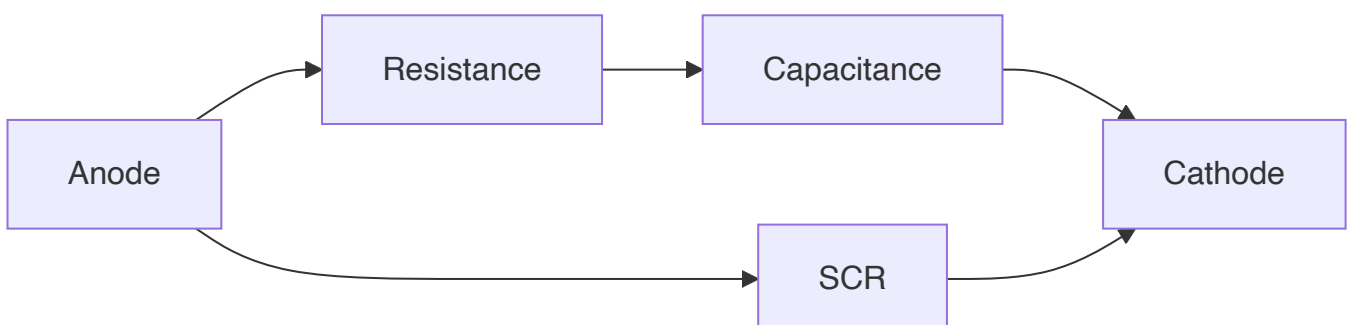

Design Steps:

Step	Calculation
1. Calculate dV/dt rating	From datasheet ($V/\mu s$)
2. Determine R value	$R = V_1/IL$ where V_1 is supply voltage and IL is load current
3. Determine C value	$C = 1/(R \times (dV/dt)_{max})$
4. RC time constant	$\tau = R \times C$ (should be greater than SCR turn-off time)

- **Resistance R:** Limits discharge current of capacitor
- **Capacitance C:** Absorbs transient energy and limits dV/dt
- **Protection:** Prevents false triggering and damage
- **Power Rating:** R must have sufficient power rating

Mnemonic: "RCSS" - Resistance-Capacitance Saves Silicon from Stress.

Question 2(a) OR [3 marks]

Define commutation and Explain class-E commutation for SCR.

Answer:

Commutation is the process of turning OFF an SCR by reducing its anode current below the holding current level.

Class-E Commutation:

Diagram:

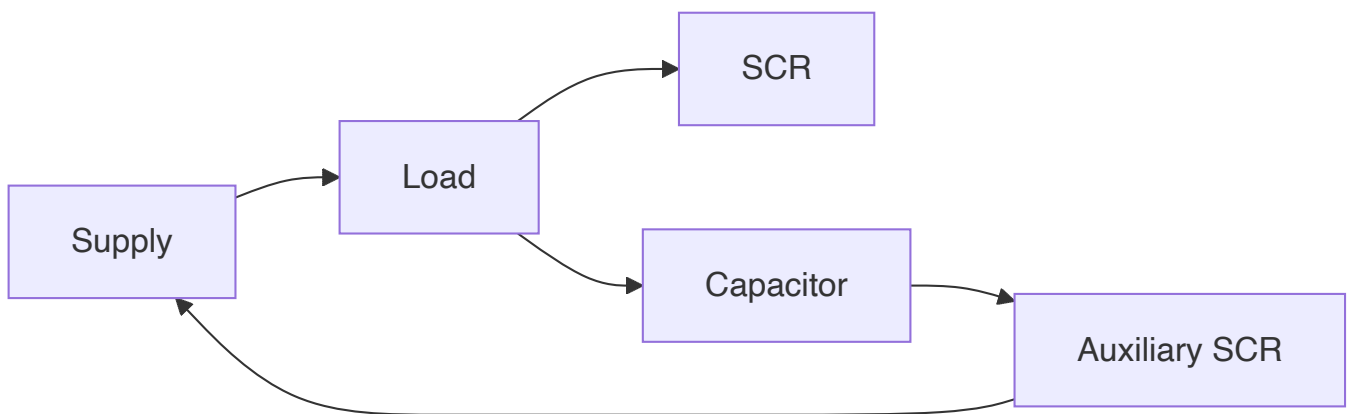

- **Auxiliary SCR:** Controls the commutation process
- **Resonant Circuit:** Forms LC resonant circuit
- **Operation:** Auxiliary SCR triggers capacitor discharge to reverse-bias main SCR
- **Application:** Used in inverters and choppers

Mnemonic: "ACE" - Auxiliary Capacitor Extinguishes conduction.

Question 2(b) OR [4 marks]

Explain Triggering of Thyristor.

Answer:

Triggering Method	Working Principle
Gate Triggering	Electrical pulse applied between gate and cathode
Temperature Triggering	Junction temperature increases to cause turn-on
Light Triggering	Photons create electron-hole pairs at junctions
dV/dt Triggering	Rapid voltage rise causes capacitive current flow
Forward Voltage Triggering	Exceeding breakover voltage causes avalanche conduction

- **Gate Triggering:** Most common and controllable method
- **Parameter Control:** Pulse width, amplitude, and rise time
- **Gate Sensitivity:** Varies with temperature
- **Protection:** Required against unwanted triggering

Mnemonic: "VITAL" - Voltage, Illumination, Temperature And Level are all triggering methods.

Question 2(c) OR [7 marks]

Explain methods to protect SCR against over voltage and current in details.

Answer:

Overvoltage Protection:

Diagram:

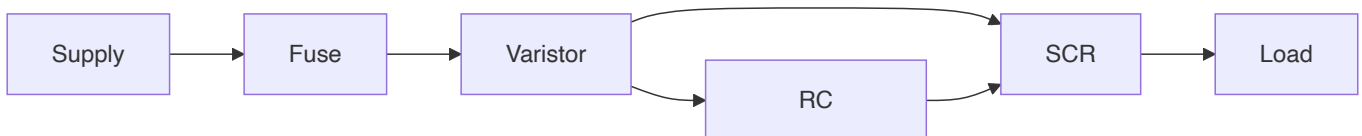

Protection Method	Working Principle
RC Snubber Circuit	Limits rate of rise of voltage (dV/dt)
Voltage Clamping	Using Zener diodes or MOVs to limit maximum voltage
Crowbar Protection	Deliberate short-circuit when voltage exceeds threshold

Overcurrent Protection:

Diagram:

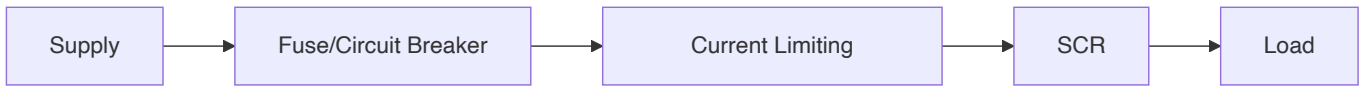

Protection Method	Working Principle
Fuses/Circuit Breakers	Disconnects circuit during fault conditions
Current Limiting Reactors	Limits fault current magnitude
Electronic Current Limiting	Sensing and control circuits limit current

- **Coordination:** Protection devices must work in coordination
- **Response Time:** Critical for effective protection
- **Multiple Layers:** For critical applications, several methods are combined

Mnemonic: "SCOPE" - Snubbers, Clamps, Overload sensors, Protectors, and Electronic limiters.

Question 3(a) [3 marks]

List the differences between single phase rectifier and poly phase rectifier.

Answer:

Parameter	Single Phase Rectifier	Poly Phase Rectifier
Input	Single phase AC supply	Multiple phase (usually 3-phase) AC supply
Output Ripple	Higher ripple content	Lower ripple content
Efficiency	Lower efficiency	Higher efficiency
Power Rating	Suitable for low power applications	Suitable for high power applications
Transformer Utilization	Lower utilization factor	Higher utilization factor

- **Ripple Factor:** Single phase has higher ripple compared to poly phase
- **Form Factor:** Better in poly phase systems
- **Size/Weight:** Poly phase systems have better power/weight ratio

Mnemonic: "PERCH" - Poly phase has Efficiency, Ripple improvement, Capacity, and Higher ratings.

Question 3(b) [4 marks]

Draw the circuit diagram of three phases Half Wave Rectifier and explain its Working.

Answer:

Three-phase half-wave rectifier converts three-phase AC into pulsating DC using three diodes.

Diagram:

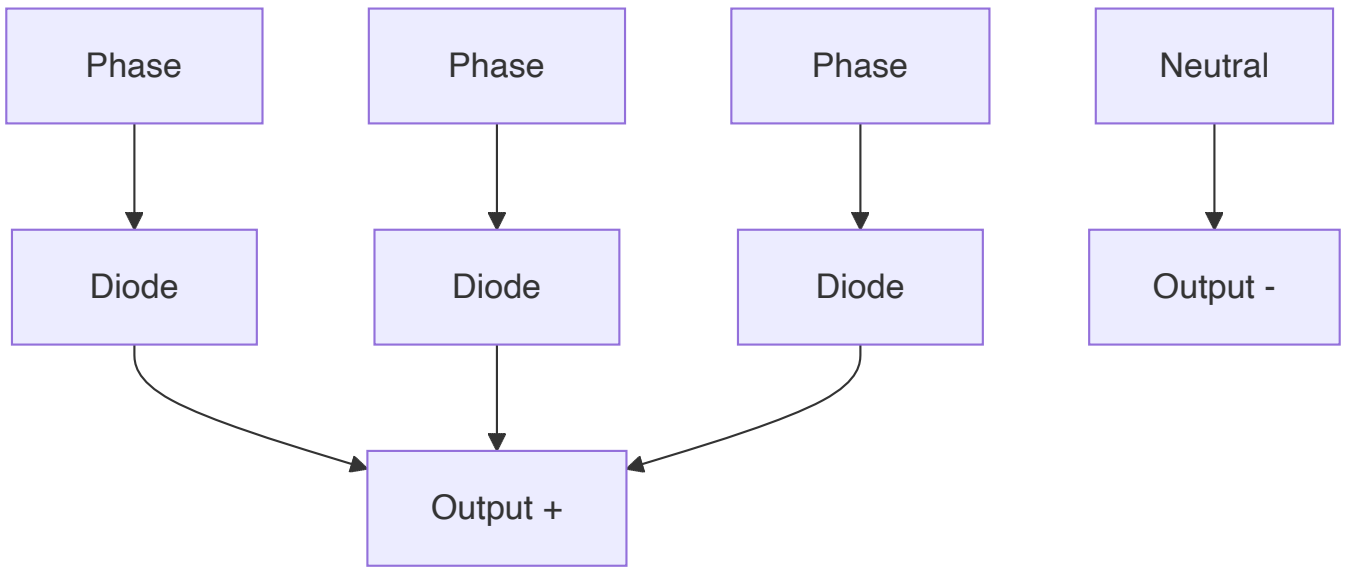

Working:

- Each diode conducts when its phase voltage is most positive
- Conduction angle of each diode is 120°
- Ripple frequency is 3 times the input frequency
- Average output voltage = $3V_m/2\pi$ (where V_m is peak phase voltage)
- Ripple factor = 0.17 (much lower than single-phase half-wave)

Mnemonic: "THREE-D" - THREE Diodes conducting sequentially.

Question 3(c) [7 marks]

Describe the working of UPS & SMPS with the help of block diagram.

Answer:

UPS (Uninterruptible Power Supply):

Diagram:

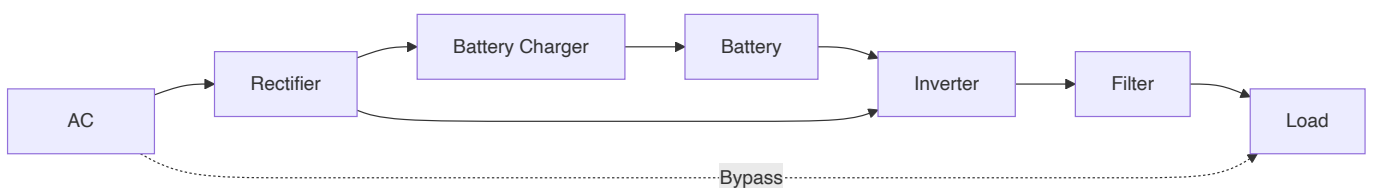

Block	Function
Rectifier	Converts AC to DC for battery charging and inverter
Battery	Stores energy for backup during power failure
Inverter	Converts DC to AC for powering load
Filter	Smooths output waveform
Bypass	Provides direct AC during maintenance

SMPS (Switched Mode Power Supply):

Diagram:

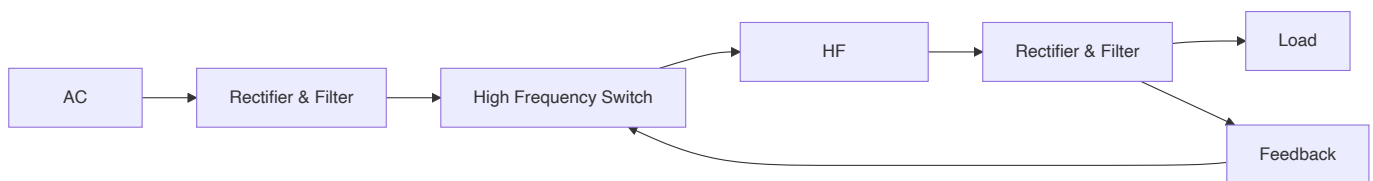

Block	Function
Rectifier & Filter	Converts AC to unregulated DC
High Frequency Switch	Chops DC into high-frequency pulses
HF Transformer	Provides isolation and voltage transformation
Output Rectifier & Filter	Converts high-frequency AC to smooth DC
Feedback Circuit	Regulates output voltage by controlling switch

- **UPS Efficiency:** 80-90%, provides backup power
- **SMPS Efficiency:** 70-90%, much smaller than linear supplies
- **Regulation:** Both provide regulated output voltage

Mnemonic: "BRIEF" - Battery backup, Rectification, Inversion, Efficient switching, Feedback control.

Question 3(a) OR [3 marks]

Explain the Principle & working of Chopper circuits.

Answer:

Chopper is a DC-to-DC converter that converts fixed DC input voltage to variable DC output voltage.

Diagram:

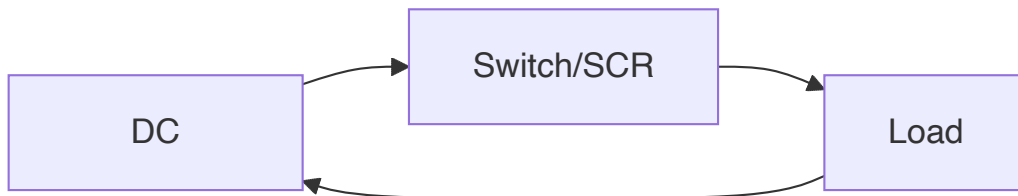
**Principle:**

- Switch (typically SCR, MOSFET, or IGBT) rapidly connects and disconnects source to load
- Output voltage controlled by duty cycle (ON time / total time)
- Average output voltage = Input voltage × Duty cycle
- **Time Ratio Control:** Varies duty cycle, keeping frequency constant
- **Frequency Modulation:** Varies frequency, keeping ON time constant
- **Applications:** DC motor control, battery-powered vehicles

Mnemonic: "CHOP" - Control High-speed Operation with Pulses.

Question 3(b) OR [4 marks]

Compare single-phase and Poly-phase rectifier circuits.

Answer:

Parameter	Single-Phase Rectifier	Poly-Phase Rectifier
Supply	Single-phase AC	Three or more phase AC
Output Waveform	More pulsating	Smoother (less pulsating)
Ripple Content	Higher (0.48 for full wave)	Lower (0.042 for 3-phase full wave)
Filtering	More filtering required	Less filtering required
Power Handling	Limited power handling	Higher power handling
Transformer Utilization	0.812 (full wave)	0.955 (3-phase full wave)
Efficiency	Lower	Higher
Size	Smaller for same power	More compact for high power

- **Harmonic Content:** Lower in poly-phase systems
- **TUF (Transformer Utilization Factor):** Higher in poly-phase systems
- **Cost-Effectiveness:** Poly-phase more economical for high power

Mnemonic: "PERIPHERY" - Poly-phase Efficiency Ripple Improvement Power Handling Economy Rating Yield.

Question 3(c) OR [7 marks]

Describe the working of solar Photovoltaic (PV) based power generation with the help of block diagram.

Answer:

Solar PV power generation converts sunlight directly into electricity using semiconductor materials.

Diagram:

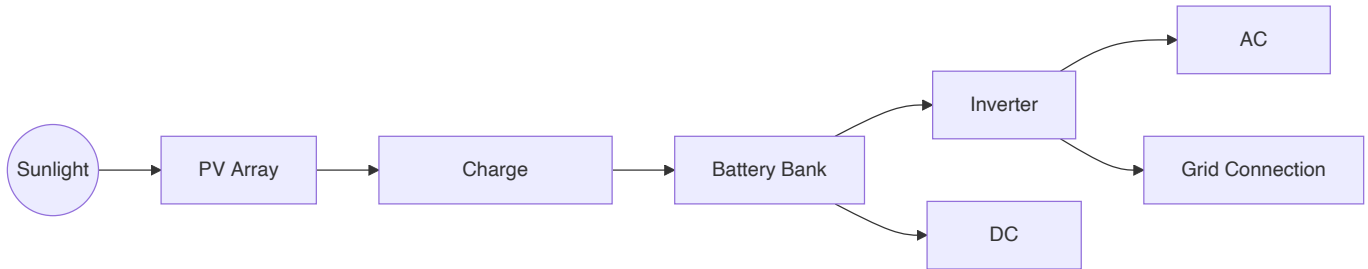

Component	Function
PV Array	Converts solar energy to DC electricity through photovoltaic effect
Charge Controller	Regulates battery charging and prevents overcharging
Battery Bank	Stores energy for use during night or cloudy conditions
Inverter	Converts DC to AC for powering AC loads
Grid Connection	Optional connection for feeding excess power to grid

Working Principle:

- **Photovoltaic Effect:** Photons from sunlight knock electrons free in semiconductor
- **Cell Structure:** P-N junction creates electric field
- **Voltage Generation:** Typical cell produces 0.5-0.6V DC
- **Array Configuration:** Series-parallel connections for desired voltage/current
- **Efficiency:** Typically 15-22% for commercial panels
- **Applications:** Residential, commercial, industrial power generation

Mnemonic: "SOLAR" - Semiconductors Oriented Light-to-electricity Array Regulation.

Question 4(a) [3 marks]

List the advantages of static switch.

Answer:

Advantages of Static Switch

No moving parts - higher reliability
Silent operation
Fast switching response (microseconds)
Longer operational life
No contact bounce or arcing
Compact size
Compatible with digital control systems
Lower maintenance requirements

- **Reliability:** No mechanical wear and tear
- **Speed:** Much faster than mechanical switches
- **Isolation:** Can provide electrical isolation

Mnemonic: "SAFE" - Speed, Arc-free, Fast response, Endurance.

Question 4(b) [4 marks]

Draw the circuit diagram of A.C. Power control using DIAC-TRIAC and Explain it.

Answer:

DIAC-TRIAC circuit provides smooth AC power control for resistive and inductive loads.

Diagram:

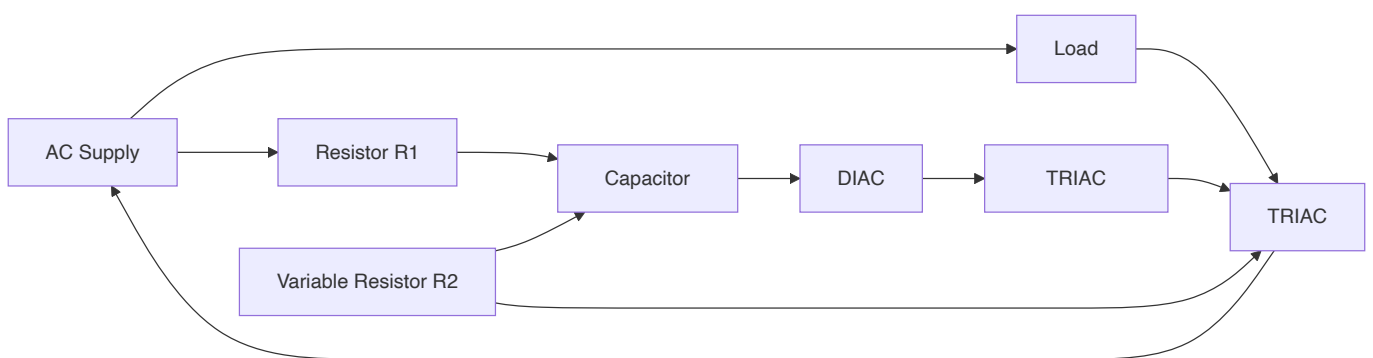

Working:

- Variable resistor R2 controls charging rate of capacitor C
- When capacitor voltage reaches DIAC breakover voltage, DIAC conducts
- DIAC delivers trigger pulse to TRIAC gate
- TRIAC conducts for remainder of half-cycle

- Process repeats for both half-cycles
- **Phase Control:** Controls power by varying firing angle
- **Applications:** Light dimmers, heater controls, motor speed control
- **Power Range:** Can control from near-zero to full power

Mnemonic: "DIRECT" - DIAC Initiates Regulated Energy Control in TRIAC.

Question 4(c) [7 marks]

Describe function of DC power control circuit using SCR with UJT in triggering circuit.

Answer:

UJT-triggered SCR circuit provides precise control of DC power to the load.

Diagram:

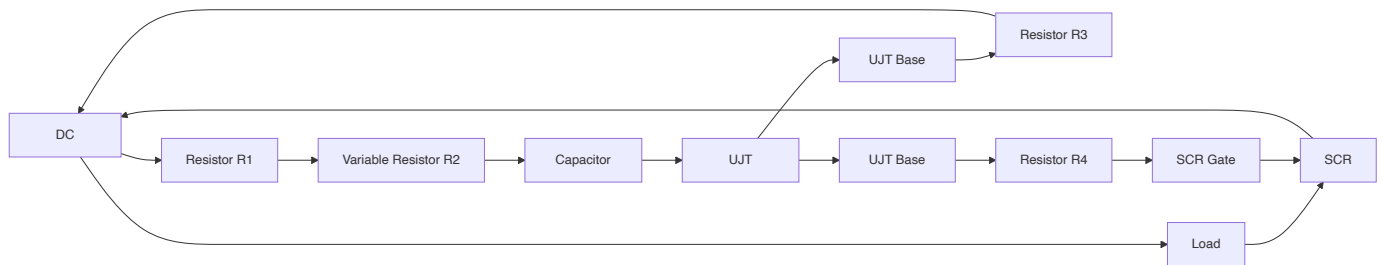

Working Principle:

Stage	Operation
Charging	R1 and R2 control charging rate of capacitor C
UJT Firing	When capacitor voltage reaches UJT firing level, UJT conducts
Pulse Generation	UJT generates sharp trigger pulse across R4
SCR Triggering	Pulse triggers SCR gate, turning SCR ON
Power Control	Variable resistor R2 adjusts timing, controlling average power

- **Precise Control:** UJT provides stable, predictable triggering
- **Applications:** Battery chargers, DC motor speed control, temperature control
- **Advantages:** Low cost, high reliability, good temperature stability
- **Control Range:** Wide range from near-zero to full power

Mnemonic: "SCRUP" - SCR Using Pulse from UJT for Power control.

Question 4(a) OR [3 marks]

Enlist applications of dielectric heating.

Answer:

Applications of Dielectric Heating

Plastic welding and sealing
Wood gluing and curing
Food processing (pre-cooking, defrosting)
Textile drying and processing
Paper and board drying
Pharmaceutical products drying
Medical applications (hyperthermia treatment)
Rubber vulcanization

- **Material Requirements:** Works best with poor conductors that have polar molecules
- **Frequency Range:** Typically 10-100 MHz
- **Advantages:** Uniform heating, faster processing, energy efficiency

Mnemonic: "POWER" - Plastics, Organics, Wood, Edibles, and Rubber processing.

Question 4(b) OR [4 marks]

Draw and explain three stage IC555 timer circuit.

Answer:

Three-stage IC555 timer circuit provides sequential timing operations.

Diagram:

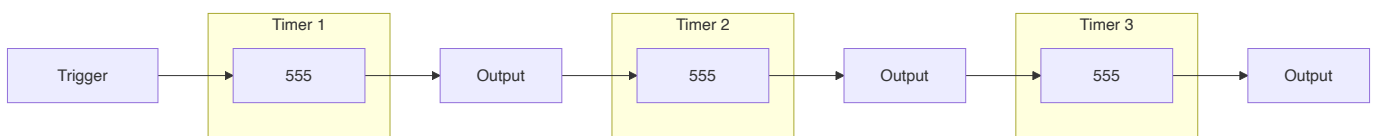

Working:

- First timer activated by external trigger
- Output of first timer triggers second timer
- Output of second timer triggers third timer
- Each timer can be independently adjusted
- **Applications:** Industrial sequencing, process control, animation effects
- **Timing Range:** Microseconds to hours with proper component selection
- **Features:** Stable timing, immune to supply variations
- **Advantages:** Simple design, reliable operation, low cost

Mnemonic: "THREE-SET" - THREE Stage Electronic Timers in sequence.

Question 4(c) OR [7 marks]

Describe the working principle of Induction heating. And List merits-demerits of Induction heating.

Answer:

Induction heating uses electromagnetic induction to heat electrically conductive materials.

Diagram:

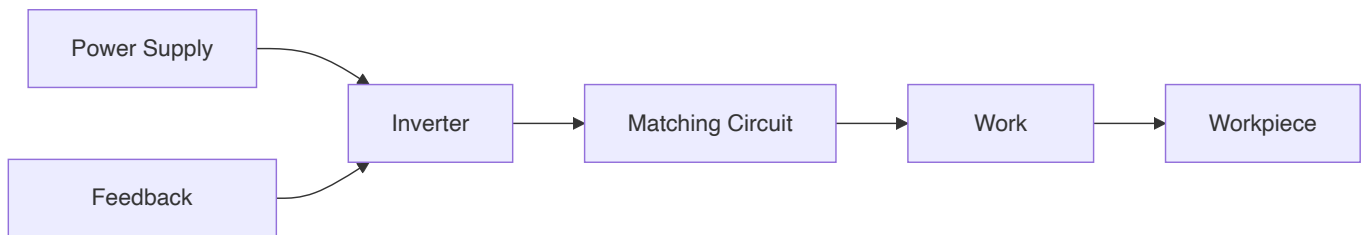

Working Principle:

- High frequency AC in work coil creates alternating magnetic field
- Magnetic field induces eddy currents in workpiece
- Eddy currents generate heat due to material resistance
- Heating occurs within the workpiece, not from external source

Merits	Demerits
Rapid heating	High initial equipment cost
Energy efficient (80-90%)	Limited to electrically conductive materials
Precise temperature control	Requires high-frequency power supply
Clean process with no combustion	Complex coil design for specific applications
Localized heating possible	High power requirements
Consistent, repeatable results	Requires water cooling systems
Environmentally friendly	Electromagnetic interference issues
Improved working conditions	Limited penetration depth

- **Frequency Range:** 1 kHz to 1 MHz depending on application
- **Applications:** Heat treatment, melting, brazing, soldering

Mnemonic: "EDDY" - Electromagnetic Device Develops Yield of heat.

Question 5(a) [3 marks]

Draw & explain solid state circuit to control dc shunt motor speed.**Answer:**

Solid-state circuit for DC shunt motor speed control uses SCR to control armature voltage.

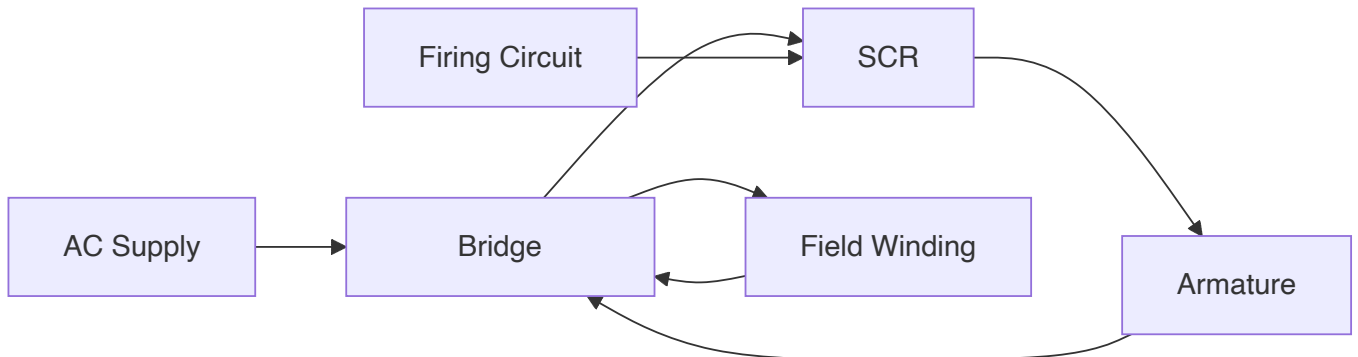
Diagram:

- **Armature Voltage Control:** SCR controls voltage to armature
- **Field Winding:** Connected directly to DC supply
- **Speed Control:** By varying SCR firing angle
- **Advantages:** Smooth control, high efficiency, compact size

Mnemonic: "SAFE" - SCR Armature Firing for Efficient control.

Question 5(b) [4 marks]**Explain working principle of stepper motor.****Answer:**

Stepper motor converts electrical pulses into discrete mechanical movements.

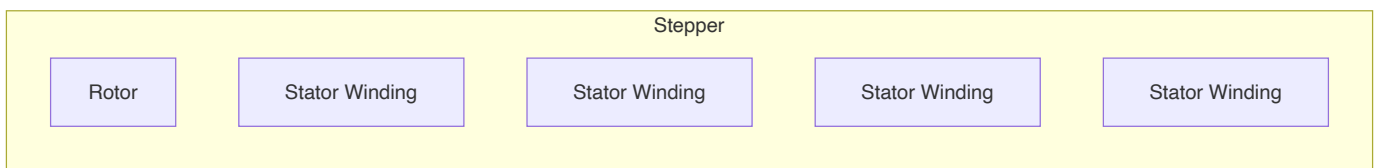
Diagram:**Working Principle:**

- Energizing stator windings in sequence creates rotating magnetic field
- Permanent magnet rotor aligns with magnetic field
- Each pulse creates rotation by exact "step" angle
- Step angle determined by motor construction (typically 1.8° or 0.9°)

Type	Characteristics
Variable Reluctance	No permanent magnet, relies on magnetic reluctance
Permanent Magnet	Uses permanent magnet rotor
Hybrid	Combines features of both types

- **Precise Positioning:** Movement in exact increment steps
- **Open-Loop Control:** No feedback needed for position control
- **Holding Torque:** Maintains position when energized

Mnemonic: "STEP" - Sequential Triggering Enables Precise positioning.

Question 5(c) [7 marks]

Draw the block diagram of PLC and explain the function of each block.

Answer:

Programmable Logic Controller (PLC) is a digital computer used for automation of industrial processes.

Diagram:

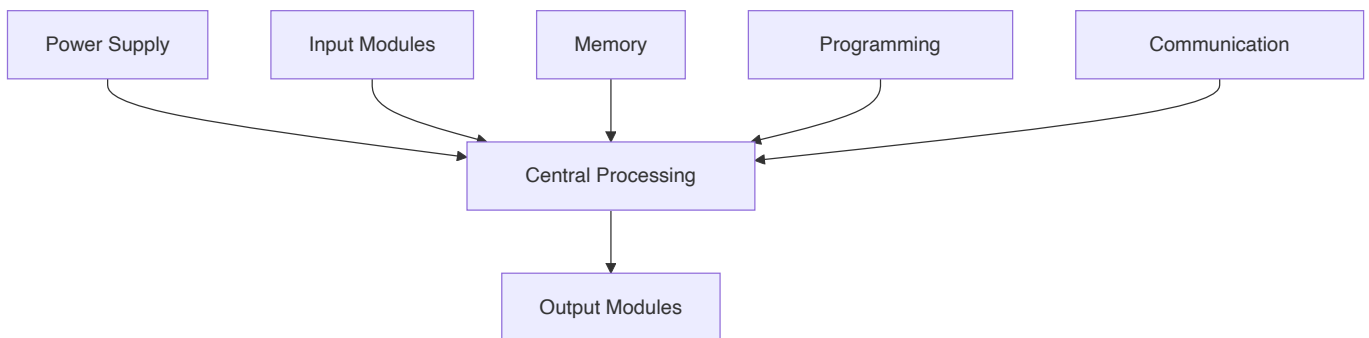

Block	Function
Power Supply	Converts main AC to DC for internal use
CPU	Executes program, processes data, manages operations
Input Modules	Interface with sensors, switches, and field devices
Output Modules	Control actuators, motors, valves, and indicators
Memory	Stores program and data (ROM, RAM, EEPROM)
Programming Device	External computer or terminal for programming
Communication Module	Interfaces with other PLCs, SCADA, HMI

- **Scan Cycle:** Input scanning → Program execution → Output updating

- **Advantages:** Reliability, flexibility, modular design, easy troubleshooting
- **Applications:** Manufacturing automation, process control, material handling
- **Programming:** Ladder logic, function block diagram, structured text

Mnemonic: "PILOT" - Processing Inputs and Logic for Outputs with Timing control.

Question 5(a) OR [3 marks]

Draw and explain the construction of DC servo motor.

Answer:

DC servo motor is designed for precise position and speed control.

Diagram:

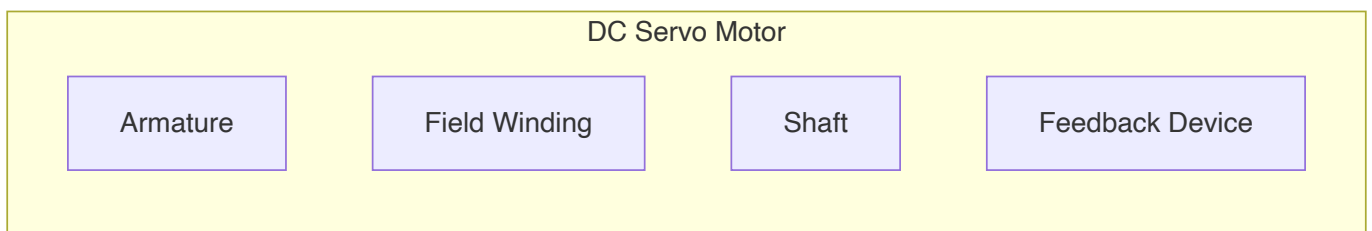

Components:

- **Armature:** Low inertia for quick response
- **Field System:** Provides magnetic field (permanent magnets in modern motors)
- **Commutator & Brushes:** Electrical connection to rotating armature
- **Feedback Device:** Position sensor (encoder/resolver/tachometer)
- **Housing:** Contains bearings and mounting provisions
- **High Torque-to-Inertia Ratio:** Allows quick starts and stops
- **Linear Torque-Speed Characteristics:** Enables precise control
- **Low Electrical Time Constant:** Fast response to control signals

Mnemonic: "SAFE" - Sensitive Armature with Feedback for Exactness.

Question 5(b) OR [4 marks]

Draw and explain the circuit to control speed of a DC series motor.

Answer:

DC series motor speed control circuit using SCR.

Diagram:

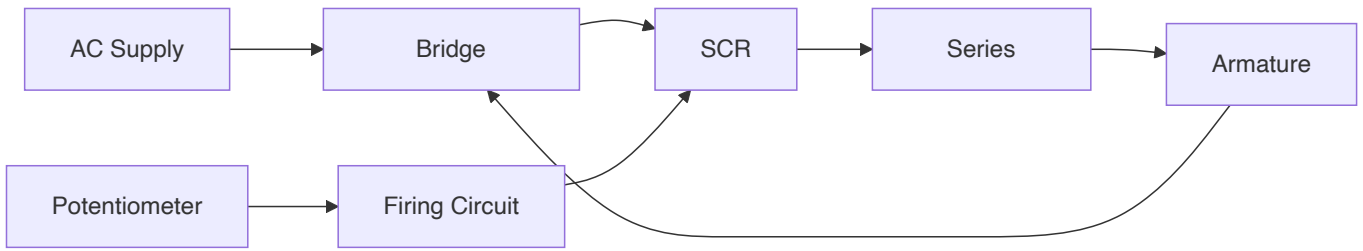

Working:

- Bridge rectifier converts AC to DC
- SCR controls average voltage to motor
- Firing angle controlled by potentiometer
- Series field and armature current is the same
- Speed varies inversely with voltage at low loads
- **Armature Voltage Control:** Primary method for speed control
- **Torque Characteristics:** High starting torque maintained
- **Speed Range:** Typically 3:1 for stable operation

Mnemonic: "SCRAM" - SCR Controls Rectified Armature and Motor speed.

Question 5(c) OR [7 marks]

Explain construction, working of Stepper motor Give and its applications

Answer:

Stepper motor is an electromechanical device that converts electrical pulses into discrete mechanical movements.

Construction:

Diagram:

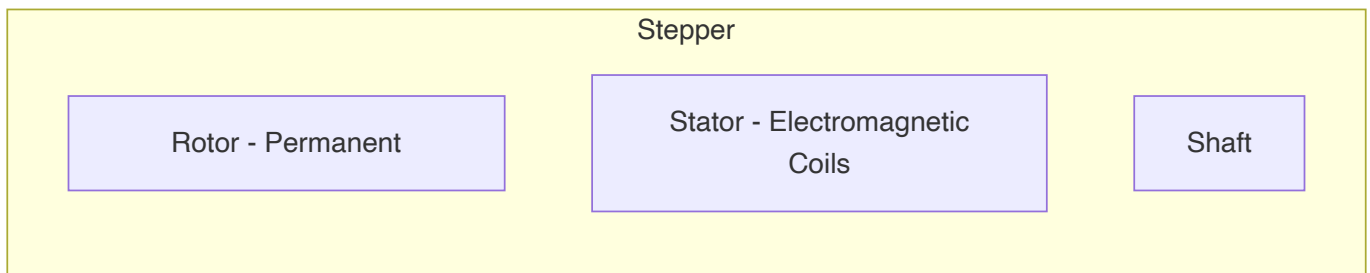

Component	Description
Stator	Contains multiple coil windings arranged in phases
Rotor	Permanent magnet or soft iron (reluctance type)
Bearings	Support shaft and allow rotation
Housing	Mechanical structure holding all components
Leads	Electrical connections to stator windings

Working Principle:

- Digital pulses energize stator windings in sequence
- Magnetic field rotates in steps around stator
- Rotor follows magnetic field in precise angular steps
- Direction controlled by sequence of energization
- Speed controlled by pulse frequency

Types of Stepper Motors:

Type	Characteristics
Variable Reluctance	No permanent magnet, high speed, low torque
Permanent Magnet	Simpler design, moderate torque, lower resolution
Hybrid	Combines both designs, high resolution, good torque

Applications:

- CNC machines and 3D printers
- Robotics and automation
- Camera lens focusing mechanisms
- Precision positioning systems
- Medical equipment
- Office equipment (printers, scanners)
- Automotive applications (headlight positioning)
- Small consumer devices

Mnemonic: "REACT" - Rotation Exactly At Controlled Timing.